

Microcalorimetric Studies on the Critical Micelle Concentration and Thermodynamic Functions of the Poly(oxyethylene) Lauryl Ether and Poly(oxyethylene glycol) Octylphenyl Ether in *N,N*-Dimethylformamide + Long-Chain Alcohol Systems at 298.15 K

Honglin Zhang,^{*,†} Ke Zhang,[†] Changqing Kong,[†] Shujuan Yang,[†] Ganzuo Li,[‡] and Li Yu[‡]

College of Chemical Science, Qufu Normal University, Qufu Shandong, 273165 P. R. China, and Key Lab for Colloid and Interface Chemistry of Shandong University, Jinan, 250100, P. R. China

The power–time curves of the micelle formation process are determined for the nonionic surfactants (Brij-35 and TX-100) in dimethylformamide (DMF) + long-chain alcohol systems by titration microcalorimetry. From the power–time curves, the critical micelle concentration (cmc) and the ΔH_m^θ are obtained with ΔG_m^θ and ΔS_m^θ calculated. For this system, the relationships among the alcohol carbon number, the alcohol concentration with cmc, and the thermodynamic functions are discussed.

1. Introduction

In comparison with the amount of work on the properties of surfactants in water, the study of the physicochemical properties of surfactants in nonaqueous solution is a rather limited field. Recently, the practical appliance of micelles and microemulsion in nonaqueous solution has increased considerably, especially in the spread of the pesticide microemulsion and the micelle catalytic reaction.^{1–7}

The physicochemical properties of nonionic surfactants in organic solutions are not similar to those in aqueous solution because of interactions among the organic solvent, the surfactant, and the cosurfactant (long-chain alcohol). A better understanding of the relationship among the surfactant, the cosurfactant, and the organic solvent is needed.

The purpose of this work is to study the effects of some long-chain alcohols on the nonionic surfactants [poly(oxyethylene) lauryl ether (Brij-35) and poly(oxyethylene glycol) octylphenyl ether (TX-100)] in *N,N*-dimethyl formamide (DMF) solution in detail.

In a previous paper,⁸ we have reported the influence of alcohols on the critical micelle concentration (cmc) and thermodynamic functions of the anionic surfactants in the nonaqueous solutions at 298.15 K. In this paper, we studied the influence of cosurfactants in nonaqueous micelle solutions from the nonionic surfactants (Brij-35 and TX-100) in DMF + long-chain alcohols system, and the cmc and the thermodynamic functions such as ΔH_m^θ , ΔG_m^θ , and ΔS_m^θ were obtained. The relationships among the cmc, the thermodynamic functions with these alcohol carbon numbers, and the alcohol concentrations are also discussed. Studies of this aspect have not been previously reported.

2. Experimental Section

2.1. Instrument. The 2277 thermal activity monitor (Sweden) was an isothermal thermostat containing 23 L of water, which holds up to four independent calorimetric units. A 4 mL stainless

steel titration ampule unit was inserted in the thermostat. A titration ampule unit was equipped with a stirrer and a stirrer motor. The stirrer shaft was rotated at the desired speed of (0 to 120) rpm. The instrument could be used within a temperature range of (293 to 353) K. The monitor was maintained at a given temperature constant within $\pm 2 \cdot 10^{-4}$ K. This system was very sensitive, and the detection limit was 0.15 μ W with the baseline stability (within a period of 24 h) of 0.2 μ W.

2.2. Materials. The solvent was DMF (analytical grade, content, mass fraction 0.998; Tianjin Kermel Chemical Reagents Development Center).

The surfactants were as follows: Brij-35 (Shanghai, Siao-pharm Chemical Reagent Co., Ltd.; hydroxyl value/(KOH mg \cdot g⁻¹), 40.0 to 60.0, H₂O < 0.03) and TX-100 (analytical grade, content, mass fraction > 0.99; Shanghai, Siao-pharm Chemical Reagent Co., Ltd.).

The cosurfactants were heptan-1-ol, octan-1-ol, nonan-1-ol, and decan-1-ol (analytical grade, content, mass fraction > 0.99; Shanghai Chemical Reagents Plant).

Solution 1 consists of 0.005 mol \cdot L⁻¹ Brij-35 in DMF solution with cosurfactant (0.5 mol \cdot L⁻¹, 1.0 mol \cdot L⁻¹, 1.5 mol \cdot L⁻¹, and 2.0 mol \cdot L⁻¹) and alcohol (heptan-1-ol, octan-1-ol, nonan-1-ol, or decan-1-ol).

Solution 2 consists of 0.005 mol \cdot L⁻¹ TX-100 in DMF solution with cosurfactant (0.5 mol \cdot L⁻¹, 1.0 mol \cdot L⁻¹, 1.5 mol \cdot L⁻¹, and 2.0 mol \cdot L⁻¹) and alcohol (heptan-1-ol, octan-1-ol, nonan-1-ol, or decan-1-ol).

The molecular structures of Brij-35, TX-100, DMF, and long-chain alcohols are shown in Table 1.





2.3. Method. A 4 mL stainless steel titration ampule unit was used in this experiment. A 2 mL organic solvent is fed into a 4 mL ampule, and titration solution 1 or 2 is maintained at a given temperature constant (298.15 K). Then, 0.5 mL titration of solution 1 or 2 was pumped into the 4 mL ampule by micro perpex pump; the speed of titration solution was 0.02 mL \cdot min⁻¹, and the operator rotated the stirrer shaft at the desired speed of 120 rpm. The schematic diagram is shown in Figure 1.

* Corresponding author. E-mail: zhanghl1946@163.com.

[†] Qufu Normal University.

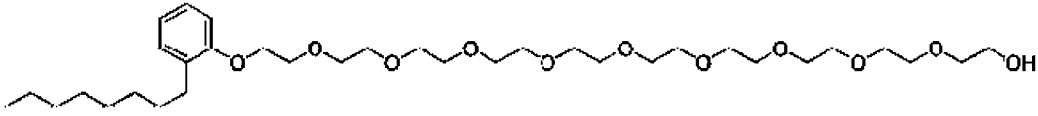
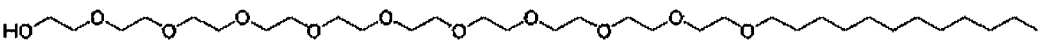
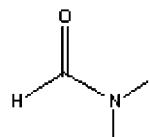
[‡] Key Lab for Colloid and Interface Chemistry of Shandong University.

Table 1. Molecular Structures of Brij-35, TX-100, DMF, and Long-Chain Alcohols

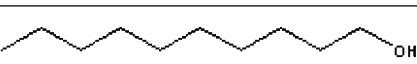
Tx-100	
Brij-35	
DMF	
heptan-1-ol	
octan-1-ol	
nonan-1-ol	
decan-1-ol	

All measurements were made three times with the average values of power–time curves obtained at 298.15 K. The experimental error was less than 0.02.

3. Results and Discussion

3.1. Determination of Critical Micelle Concentration (cmc) and Discussion. The power–time curves of the micelle formation process are determined respectively for Brij-35 and TX-100 in DMF which contain different alcohols (heptan-1-ol, octan-1-ol, nonan-1-ol, or decan-1-ol separately) of $0.5 \text{ mol}\cdot\text{L}^{-1}$, $1.0 \text{ mol}\cdot\text{L}^{-1}$, $1.5 \text{ mol}\cdot\text{L}^{-1}$, and $2.0 \text{ mol}\cdot\text{L}^{-1}$ at 298.15 K. Partial curves are shown in Figures 2 and 3.

The cmc could be obtained according to the corresponding concentration at the lowest point of the power–time curves.⁸

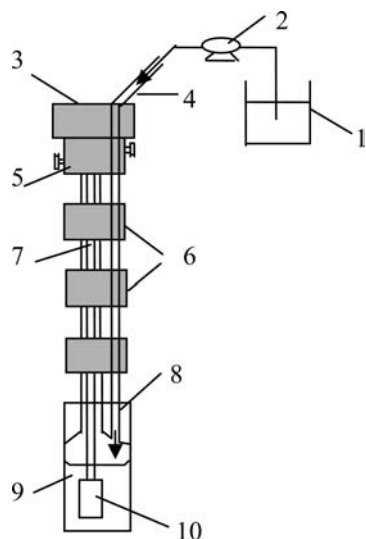

Figure 1. Schematic diagram of titration operation: 1, titrate solution; 2, micro perpep pump; 3, stirrer motor; 4, titration tube for cannula; 5, main tube; 6, heat sink; 7, titration shaft; 8, ampule lid coned; 9, 4 mL ampule; 10, turbine stirrer.

The cmc of Brij-35 and TX-100 in DMF, which contain various concentrations of alcohols at 298.15 K, is shown in Table 2.

The plots of the cmc of Brij-35 and TX-100 against the concentration (c) of the alcohol in DMF system at 298.15 K and partial curves are shown in Figure 4. The cmc decreases with the increase in concentration of alcohol.

The plots of the cmc of Brij-35 and TX-100 against the carbon number (n) of the alcohol in DMF system at 298.15 K and partial curves are shown in Figure 5. The cmc decreases with the increase in the carbon number (n) of the alcohol.

3.2. Measurement of ΔH_m^0 and Discussion. The areas of the power–time curves, which represent the thermal effect, are obtained. Parallel control experiments are also conducted to achieve the thermal effect caused by dilution of alcohol in the organic solvent. The standard enthalpy change (ΔH_m^0) of the micelle formation process of Brij-35 and TX-100 in DMF at

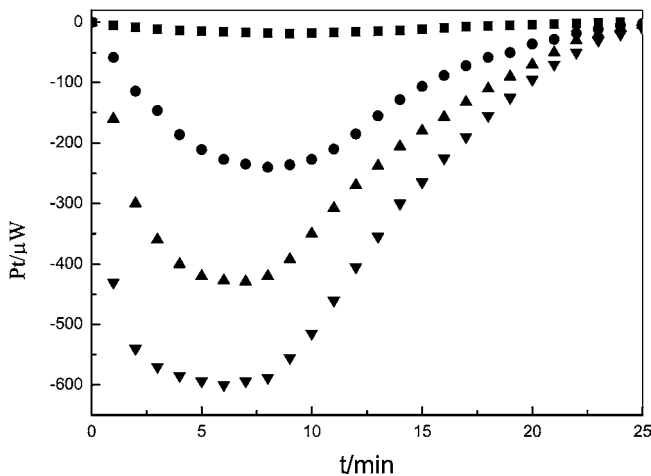

Figure 2. Power–time curves of the micelle formation process for the $0.005 \text{ mol}\cdot\text{L}^{-1}$ TX-100 in DMF system contain different concentrations of octan-1-ol at 298.15 K. ■, $0.5 \text{ mol}\cdot\text{L}^{-1}$; ●, $1.0 \text{ mol}\cdot\text{L}^{-1}$; ▲, $1.5 \text{ mol}\cdot\text{L}^{-1}$; ▼, $2.0 \text{ mol}\cdot\text{L}^{-1}$.

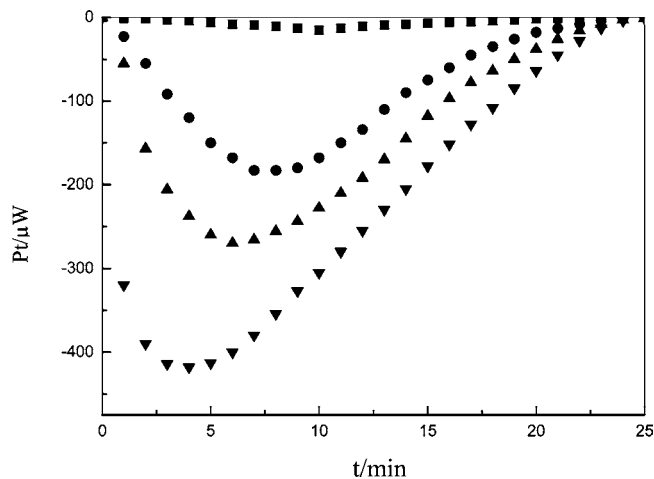

Figure 3. Power–time curves of the micelle formation process for the 0.005 mol·L⁻¹ Brij35 in DMF system containing different concentrations of octan-1-ol at 298.15 K. ■, 0.5 mol·L⁻¹; ●, 1.0 mol·L⁻¹; ▲, 1.5 mol·L⁻¹; ▼, 2.0 mol·L⁻¹.

Table 2. Critical Micelle Concentration (cmc) of the TX-100 and Brij-35 in DMF System in the Presence of Different Concentrations (c) of Alcohols at 298.15 K

10 ⁴ cmc mol·L ⁻¹	alcohol	c/mol·L ⁻¹			
		0.5	1.0	1.5	2.0
TX-100	heptan-1-ol	5.80 ± 0.06	5.28 ± 0.06	4.35 ± 0.05	3.64 ± 0.04
	octan-1-ol	5.56 ± 0.06	4.89 ± 0.06	4.18 ± 0.05	3.48 ± 0.04
	nonan-1-ol	4.92 ± 0.05	4.31 ± 0.05	3.72 ± 0.04	3.04 ± 0.03
	decan-1-ol	4.38 ± 0.05	3.76 ± 0.04	3.04 ± 0.03	2.63 ± 0.03
Brij-35	heptan-1-ol	2.88 ± 0.03	2.63 ± 0.03	2.38 ± 0.03	2.17 ± 0.02
	octan-1-ol	2.58 ± 0.03	2.34 ± 0.03	2.08 ± 0.02	1.84 ± 0.02
	nonan-1-ol	2.33 ± 0.03	2.07 ± 0.02	1.86 ± 0.02	1.56 ± 0.02
	decan-1-ol	1.95 ± 0.02	1.68 ± 0.02	1.38 ± 0.02	1.10 ± 0.01

various concentrations of alcohols is calculated through the total heat with cmc. The data of ΔH_m^θ are given in Table 3.

The plot of the enthalpy change (ΔH_m^θ) of Brij-35 and TX-100 against the concentration of alcohol in DMF system is shown in Figure 6. The ΔH_m^θ decreases with the increase in concentration of alcohol.

The plot of the enthalpy change (ΔH_m^θ) of Brij-35 and TX-100 against the carbon number (n) of the alcohol in DMF system is shown in Figure 7. The ΔH_m^θ decreases with the increase in carbon number of alcohol.

The micelle formation process is mainly determined by the hydrophobic action of surfactant and cosurfactant in DMF. Under the conditions of identical temperature, the increase of alcohol's concentration could cause the increase of hydrophobic action because the hydrophobic action of the long-chain alcohol is bigger than that of DMF. With the increase of alcohol's concentration, the increase of the absolute value of ΔH_m^θ is similar to the data of Table 3.

Table 3. ΔH_m^θ of the Micelle Formation Process of the TX-100 and Brij-35 in DMF System and the Presence of Different Concentrations (c) of Alcohols at 298.15 K

ΔH_m^θ kJ·mol ⁻¹	alcohol	c/mol·L ⁻¹			
		0.5	1.0	1.5	2.0
TX-100	heptan-1-ol	-3.188 ± 0.04	-20.66 ± 0.29	-41.50 ± 0.65	-66.00 ± 0.86
	octan-1-ol	-8.480 ± 0.10	-41.00 ± 0.65	-70.80 ± 0.92	-101.0 ± 1.35
	nonan-1-ol	-9.90 ± 0.11	-48.00 ± 0.69	-96.40 ± 1.22	-140.0 ± 1.97
	decan-1-ol	-10.00 ± 0.13	-63.00 ± 0.81	-118.0 ± 1.45	-164.0 ± 2.32
Brij-35	heptan-1-ol	-4.00 ± 0.04	-19.33 ± 0.25	-51.20 ± 0.69	-91.20 ± 1.30
	octan-1-ol	-7.00 ± 0.09	-32.60 ± 0.34	-69.40 ± 0.84	-112.2 ± 1.62
	nonan-1-ol	-9.90 ± 0.14	-47.50 ± 0.58	-87.80 ± 0.93	-134.8 ± 1.84
	decan-1-ol	-13.20 ± 0.16	-65.00 ± 0.73	-114.0 ± 1.42	-155.0 ± 2.25

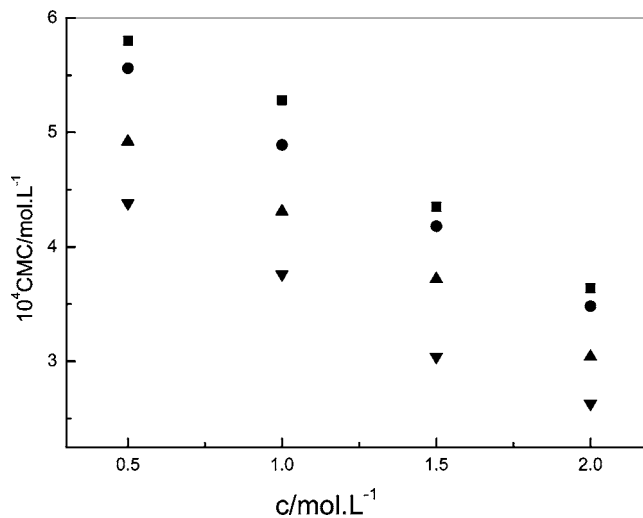

Figure 4. cmc–c curves of the 0.005 mol·L⁻¹ Brij-35 in DMF system in the presence of different alcohols of different concentrations at 298.15 K. ■, heptan-1-ol; ●, octan-1-ol; ▲, nonan-1-ol; ▼, decan-1-ol.

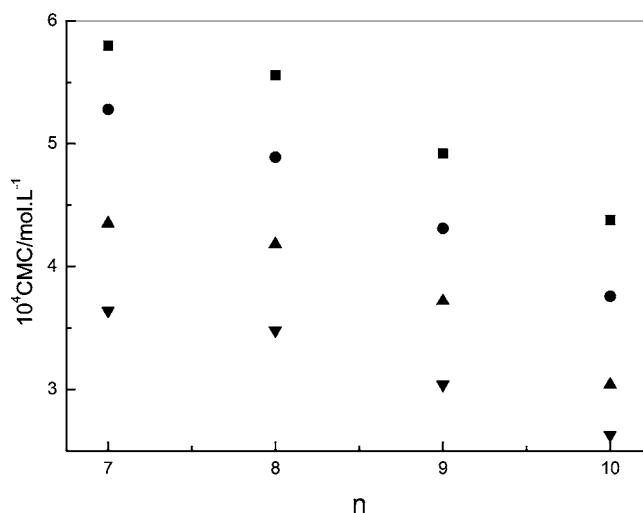

Figure 5. cmc– n curves for the TX-100 in DMF system in the presence of different carbon numbers (n) of alcohols at 298.15 K. ■, 0.5 mol·L⁻¹; ●, 1.0 mol·L⁻¹; ▲, 1.5 mol·L⁻¹; ▼, 2.0 mol·L⁻¹.

3.3. Calculation of the Free Energy and the Entropy and Discussion. The thermodynamic functions (ΔG_m^θ , ΔS_m^θ) for the Brij-35 and TX-100 in DMF system containing alcohols (heptan-1-ol, octan-1-ol, nonan-1-ol, or decan-1-ol) are calculated according to eqs 1 and 2.⁹

$$\Delta G_m^\theta = RT \ln X_{\text{cmc}} \quad (1)$$

$$\Delta G_m^\theta = \Delta H_m^\theta - T\Delta S_m^\theta \quad (2)$$

X_{cmc} is the mole fraction of surfactant in the solution.

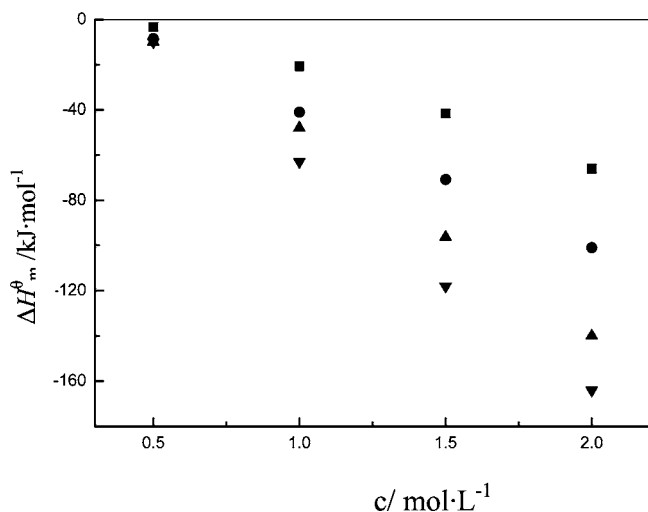

Figure 6. ΔH_m^θ - c curves for the TX-100 in DMF and the presence of different concentrations of alcohol at 298.15 K. ■, heptan-1-ol; ●, octan-1-ol; ▲, nonan-1-ol; ▼, decan-1-ol.

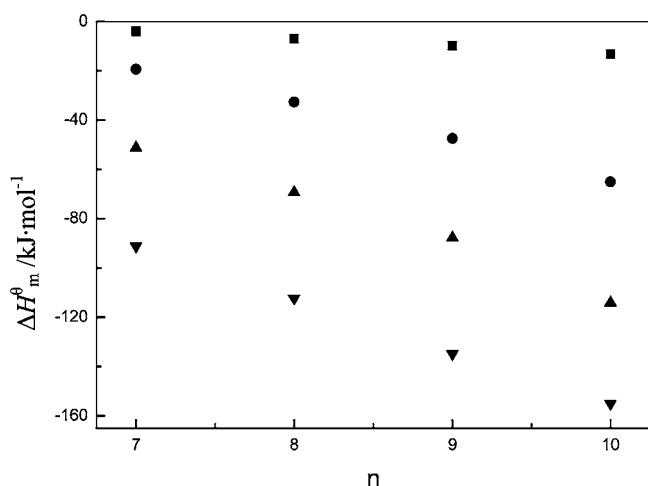

Figure 7. ΔH_m^θ - n curves for the Brij-35 in DMF system and the presence of different carbon numbers (n) of alcohols at 298.15 K. ■, 0.5 mol·L⁻¹; ●, 1.0 mol·L⁻¹; ▲, 1.5 mol·L⁻¹; ▼, 2.0 mol·L⁻¹.

These ΔG_m^θ and ΔS_m^θ of Brij-35 and TX-100 in DMF, which contain different concentrations of alcohol, could also be obtained. The values of the thermodynamic functions (ΔG_m^θ , ΔS_m^θ) are shown in Table 4.

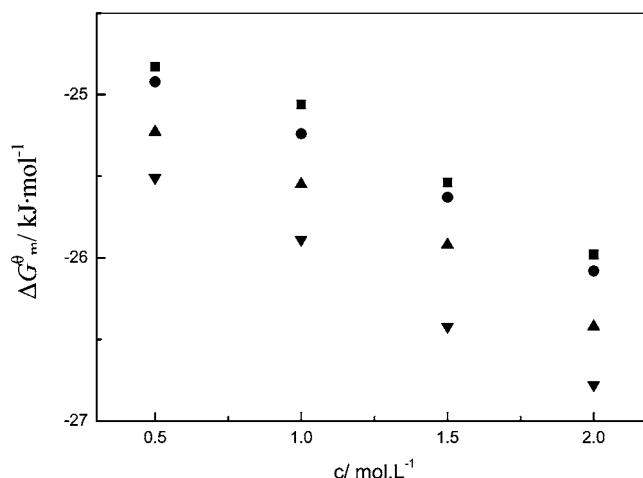

Figure 8. ΔG_m^θ - c curves for the TX-100 in DMF and the presence of different concentrations of alcohols at 298.15 K. ■, heptan-1-ol; ●, octan-1-ol; ▲, nonan-1-ol; ▼, decan-1-ol.

The plots of the ΔG_m^θ and ΔS_m^θ of Brij-35 and TX-100 against the concentrations of alcohol in DMF system at 298.15 K and partial curves are shown in Figure 8. These values of ΔG_m^θ and ΔS_m^θ of Brij-35 and TX-100 decrease with the increase in concentration of alcohol.

The plots of ΔG_m^θ and ΔS_m^θ of Brij-35 and TX-100 against the carbon number (n) of alcohol could be obtained. Partial curves are shown in Figure 9. These ΔG_m^θ and ΔS_m^θ decrease with the increase in carbon number of alcohol.

According to the data, the micelle formation proceedings, which are driven by entropy or enthalpy, could be discussed.

For an aqueous system of anionic surfactants, the data¹⁰ indicate that the negative values of ΔG_m^θ (about -20 to -30) kJ·mol⁻¹ are mainly ascribed to the large positive value of ΔS_m^θ ($T\Delta S_m^\theta$ about $(29$ to $49)$ kJ·mol⁻¹). The value of ΔH_m^θ (about $(2.0$ to $6.0)$ kJ·mol⁻¹) is much smaller than that of $T\Delta S_m^\theta$. Therefore, the micellization process in aqueous solution is governed by entropy.

On the basis of the above theoretical approach, we can also discuss the driving force of our experimental system.

For the nonionic surfactant (Brij-35 and TX-100) and DMF + long-chain alcohol system, the data (see Tables 2 and 3) indicate that the negative values of ΔG_m^θ (about -24 to -26) kJ·mol⁻¹ are minor due to the large negative values of ΔH_m^θ (about $(-7$ to $-150)$ J·K⁻¹·mol⁻¹). The value of $T\Delta S_m^\theta$ (about

Table 4. Thermodynamic Functions (ΔG_m^θ , ΔS_m^θ) of the TX-100 and Brij-35 in DMF System and the Presence of Different Concentrations (c) of Alcohols at 298.15 K

surfactant	alcohol	function value	$c/\text{mol}\cdot\text{L}^{-1}$			
			0.5	1.0	1.5	2.0
TX-100	heptan-1-ol	$\Delta G_m^\theta/\text{kJ}\cdot\text{mol}^{-1}$	-24.83	-25.06	-25.54	-25.98
		$\Delta S_m^\theta/\text{J}\cdot\text{K}^{-1}\cdot\text{mol}^{-1}$	72.62	69.33	-53.56	-134.3
	octan-1-ol	$\Delta G_m^\theta/\text{kJ}\cdot\text{mol}^{-1}$	-24.92	-25.24	-25.63	-26.08
		$\Delta S_m^\theta/\text{J}\cdot\text{K}^{-1}\cdot\text{mol}^{-1}$	55.17	-52.89	-151.6	-251.4
	nonan-1-ol	$\Delta G_m^\theta/\text{kJ}\cdot\text{mol}^{-1}$	-25.23	-25.55	-25.92	-26.42
		$\Delta S_m^\theta/\text{J}\cdot\text{K}^{-1}\cdot\text{mol}^{-1}$	51.44	-75.34	-236.5	-381.1
	decan-1-ol	$\Delta G_m^\theta/\text{kJ}\cdot\text{mol}^{-1}$	-25.51	-25.89	-26.42	-26.78
		$\Delta S_m^\theta/\text{J}\cdot\text{K}^{-1}\cdot\text{mol}^{-1}$	52.05	-46.13	-56.42	-70.01
Brij-35	heptan-1-ol	$\Delta G_m^\theta/\text{kJ}\cdot\text{mol}^{-1}$	-26.55	-26.78	-27.03	-27.25
		$\Delta S_m^\theta/\text{J}\cdot\text{K}^{-1}\cdot\text{mol}^{-1}$	75.67	25.00	-81.11	-214.6
	octan-1-ol	$\Delta G_m^\theta/\text{kJ}\cdot\text{mol}^{-1}$	-26.83	-27.07	-27.36	-27.66
		$\Delta S_m^\theta/\text{J}\cdot\text{K}^{-1}\cdot\text{mol}^{-1}$	66.54	-18.56	-141.4	-283.7
	nonan-1-ol	$\Delta G_m^\theta/\text{kJ}\cdot\text{mol}^{-1}$	-27.08	-27.37	-27.64	-28.07
		$\Delta S_m^\theta/\text{J}\cdot\text{K}^{-1}\cdot\text{mol}^{-1}$	57.65	-67.55	-201.9	-358.2
	decan-1-ol	$\Delta G_m^\theta/\text{kJ}\cdot\text{mol}^{-1}$	-27.52	-27.89	-28.38	-28.94
		$\Delta S_m^\theta/\text{J}\cdot\text{K}^{-1}\cdot\text{mol}^{-1}$	48.05	-124.5	-287.3	-423.0

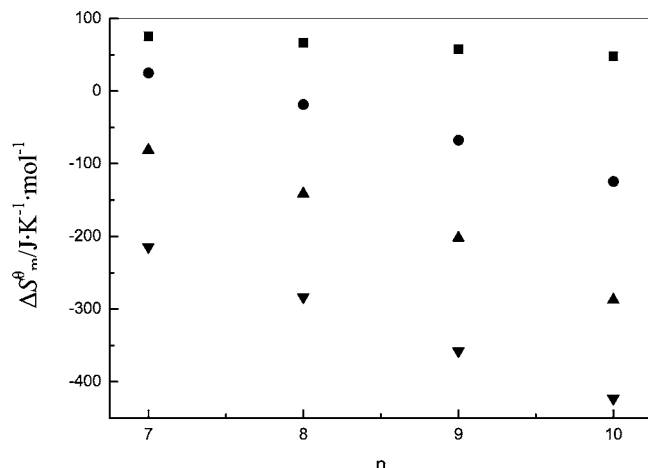

Figure 9. ΔS_m^θ - n curves for the Brij-35 in DMF system and the presence of different carbon numbers of alcohols at 298.15 K. ■, 0.5 mol·L⁻¹; ●, 1.0 mol·L⁻¹; ▲, 1.5 mol·L⁻¹; ▼, 2.0 mol·L⁻¹.

(17 to -124) kJ·mol⁻¹) is larger than the value of ΔH_m^θ . That shows that the enthalpy is the driving force. There exists a tendency for the hydrophobic group of the nonionic surfactant to transfer from the solvent environment to the interior of the micelle.

4. Conclusion

From the experimental results, the following conclusions can be obtained. For the system which contains identical alcohol concentrations at the same temperature, the values of cmc, ΔH_m^θ , ΔG_m^θ , and ΔS_m^θ decrease with the increase in the carbon number of the alcohol. For each alcohol at the same temperature, the cmc and ΔG_m^θ increase, while the ΔH_m^θ and ΔS_m^θ decrease with the increase of the alcohol concentration.

In a word, the power-time curves of the micelle formation process contain much information, from which the cmc and ΔH_m^θ could be determined with ΔG_m^θ and ΔS_m^θ calculated. This study is significant for theory and application.

Literature Cited

- (1) Evans, D. F.; Miller, D. D. *Organized Solutions*; Marcel Dekker: New York, 1992.
- (2) Nakano, T.; Sugihara, G.; Nakashima, T.; Yu, S. Thermodynamic study of mixed hydrocarbon/fluorocarbon surfactant system by conductometric and fluorimetric techniques. *Langmuir* **2002**, *18*, 8777-8785.
- (3) Wang, X.; Li, Y.; Wang, J.; Wang, Y.; Ye, J.; Yan, H. Interaction of cationic Gemini surfactants with hydrophobically modified poly(acrylamides) studied by fluorescence and microcalorimetry. *J. Phys. Chem. B* **2005**, *109*, 12850-12855.
- (4) Li, Y.; Reeve, J.; Wang, Y.; Thomas, R. K.; Wang, J.; Yan, H. Microcalorimetric study on micellization of nonionic surfactants with a benzene ring or adamantane in their hydrophobic chains. *J. Phys. Chem. B* **2005**, *109*, 16070-16074.
- (5) Salim Akhter, M. Effect of solubilization of alcohols on critical micelle concentration of non-aqueous micelle solution. *Colloids Surf., A* **1999**, *157*, 203-210.
- (6) Salim Akhter, M.; Sadeq, M.; Lawi, A. Influence of alcohols on the critical micelle concentration of non-aqueous micelle solution. *Colloids Surf., A* **2000**, *164*, 247-255.
- (7) Salim Akhter, M.; Sadeq, M.; Lawi, A. The effect of organic additives on critical micelle concentration of non-aqueous micelle solution. *Colloids Surf., A* **2000**, *175*, 311-320.
- (8) Zhang, H. L.; Kong, Z.; Yan, Y. M.; Li, G. Z.; Yu, L. Microcalorimetric study of the influence of alcohols on the critical micelle concentration and thermodynamic functions of non-aqueous micelle solutions at 298.15 K. *J. Chem. Eng. Data* **2008**, *53*, 327-330.
- (9) Myers, D. *Surfaces, Interface, and Colloids: Principles and Application*, 2nd ed.; Wiley: New York, 1999.
- (10) Attwood, D.; Florence, A. T. *Surfactant systems - Their Chemistry, pharmacy and biology*; Chapman and Hall: London, 1983.

Received for review October 6, 2009. Accepted January 25, 2010. This part of the work is supported by the National Natural Science Foundation (30370945) and Natural Science Foundation of Shandong Province of China (Y2006B13).

JE900806M